



# The Hamptons

Little souvenirs





# The Hamptons

Little souvenirs



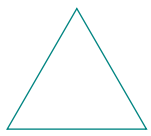





**CARMEN**  
true tiles

# Index













Índice

			
11x13 cm / 4"x5"	5x15 cm / 2"x6"	6,5x13 cm / 2,5"x5"	5x18 cm / 2"x7"
Pág. 16	Pág. 22	Pág. 28	Pág. 34

Shine / Brillo

Kirk	Havens	Tiana	Gin
			
Snow	Mist	Smoke	Night
			
Acqua	Victorian Green	Sky	Palladian
			
Pink	Cherry	Pink	Cherry

Shine crackled / Brillo craquelado

Foster Crackled	Mecox Crackled	Orient Crackled	Cooper Crackled
			
Snow	Mist	Smoke	Night
			
Acqua	Victorian Green	Sky	Palladian
			
Pink	Cherry	Pink	Cherry



**Carmen is a declaration of love to the true ceramic essence: small size products with a decorative vocation. Touch have recovered and updated ceramic classics typical of the industrial history and Mediterranean handicraft. Our aim is to offer a range of delicate and technically evolved products that adapt to the needs of any project. Carmen is APE Grupo's brand specialized in small size ceramic tiles.**

Carmen es una declaración de amor a la verdadera esencia cerámica: productos de pequeño formato con vocación decorativa. Hemos recuperado y actualizado clásicos cerámicos propios de la historia industrial y artesana mediterránea. El objetivo es ofrecer una serie de productos delicados y técnicamente evolucionados que se adapten a las necesidades de los proyectos. Carmen es la marca de APE Grupo especializada en cerámica de pequeño formato.



True tiles



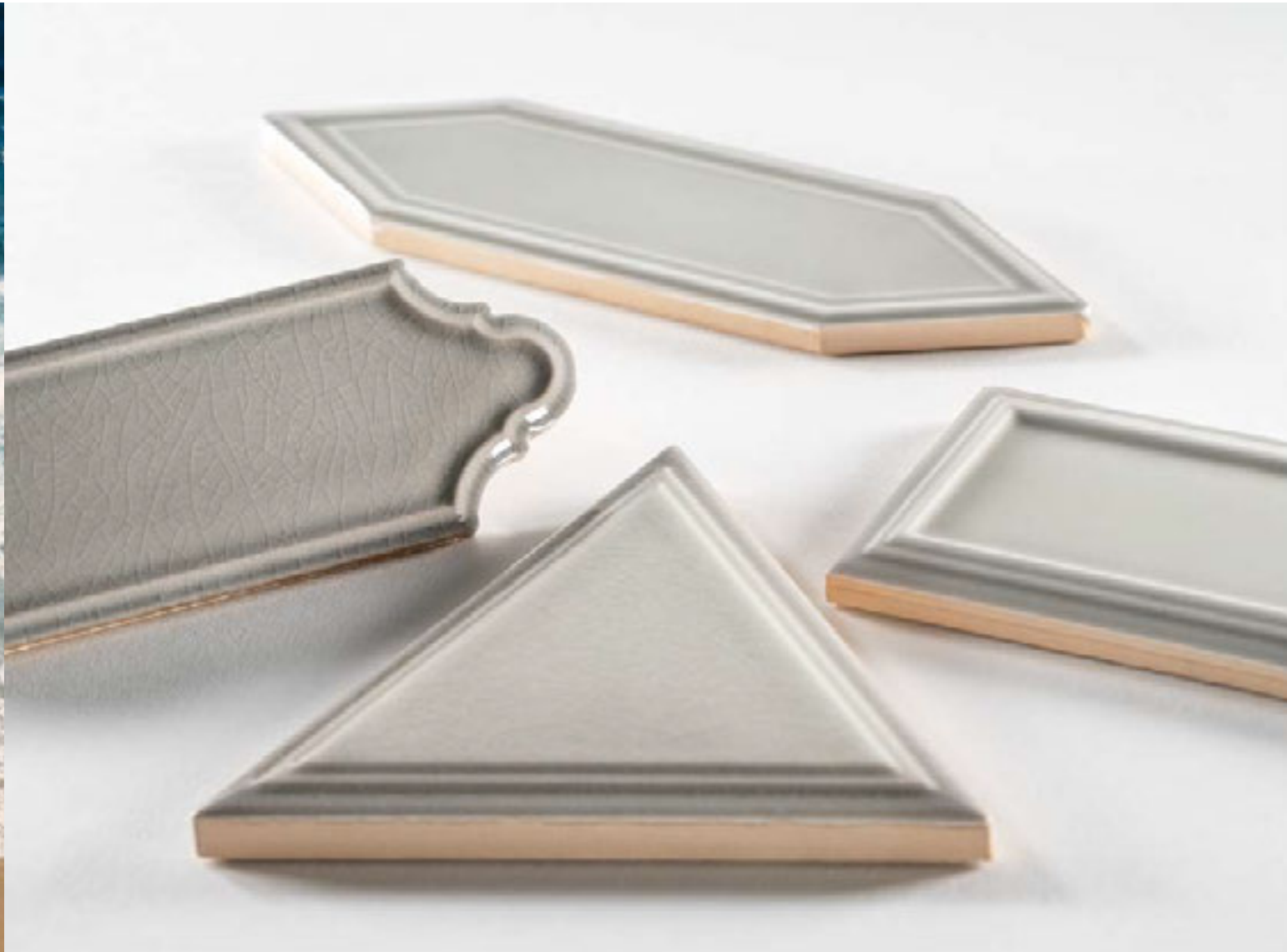
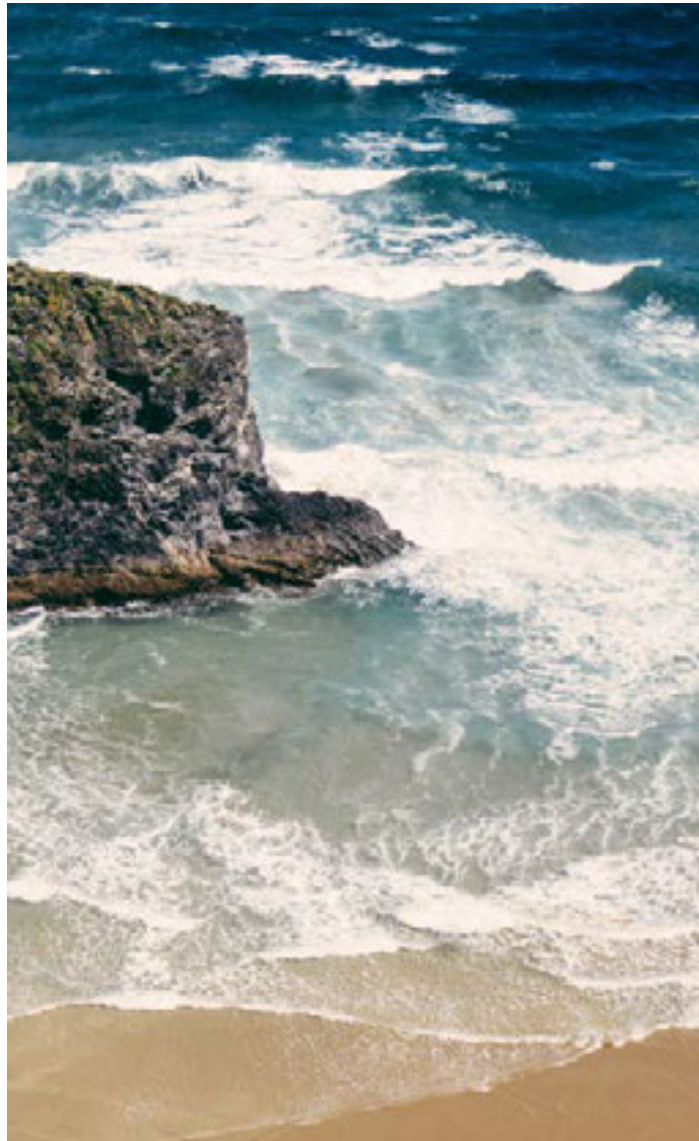

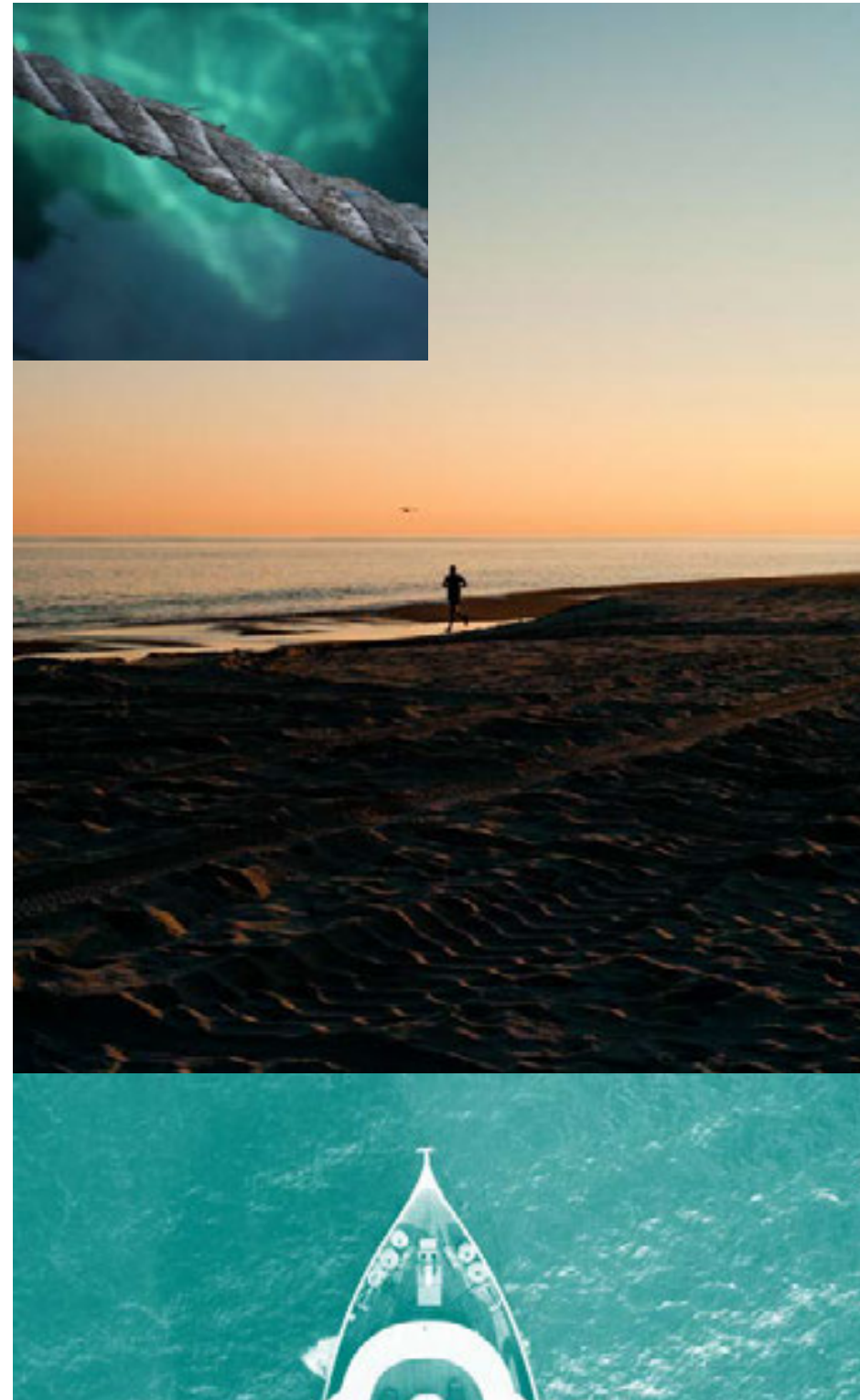

# The Hamptons

## Little souvenirs

When the first European settlers set sail for the new world, they created a new home full of tributes to their roots. The Hamptons, belonging to the English colony of New York, became a holiday retreat for wealthy families. The latest trends of the time were shipped over to decorate their mansions, which were true examples of English luxury. These included ceramic tiles, which fused Victorian taste with Mediterranean spirit.

The Hamptons is our tribute to the decorative style that the settlers took to the United States. A collection of small and varied formats that echoes a clearly Mediterranean classic tile, but with an English spirit. Two traditions of materials united by a love of the sea.

**True tiles!**

Cuando los primeros colonos europeos partieron al nuevo mundo, crearon allí un nuevo hogar lleno de homenajes a sus raíces. The Hamptons, perteneciente a la colonia inglesa de New York, se convirtió en una zona de retiro para familias adineradas. En sus barcos importaban las últimas tendencias de la época destinadas a decorar sus mansiones, verdaderos ejemplos de lujo inglés. Una de ellas fueron las las baldosas cerámicas, que combinaban el gusto victoriano, con el espíritu mediterráneo cerámico.

The Hamptons es nuestro homenaje al estilo decorativo que los colonos llevaron a Estados Unidos. Una colección de pequeño y variado formato que recupera un clásico cerámico claramente mediterráneo, pero con espíritu anglosajón. Dos tradiciones de materiales unidas por el amor al mar.

¡Auténticos True Tiles!



# Ceramics with a Mediterranean spirit

Cerámica con espíritu mediterráneo

Here at Carmen we like to stick to our roots, wherever they may be. That's why we've travelled to the Americas to recover a material of Mediterranean origin—ceramic—that reached the New World via England. We've retrieved four classic tile design formats in an even smaller format. Small in appearance, big in emotion.

En Carmen nos preocupamos por mantener vivas nuestras raíces, estén donde estén. Por eso viajamos al continente americano para recuperar un material de origen mediterráneo —la cerámica— que llegó al nuevo mundo a través de Inglaterra. Recuperamos cuatro nuevos formatos clásicos del diseño cerámico en un formato aún más reducido. Pequeño en apariencia, grande en emoción.



The Hamptons, part of the East End of Long Island (New York), is one of the most exclusive vacation destinations in the USA.

The Hamptons, en el este de Long Island (New York), es uno de los destinos vacacionales más exclusivos de los Estados Unidos.



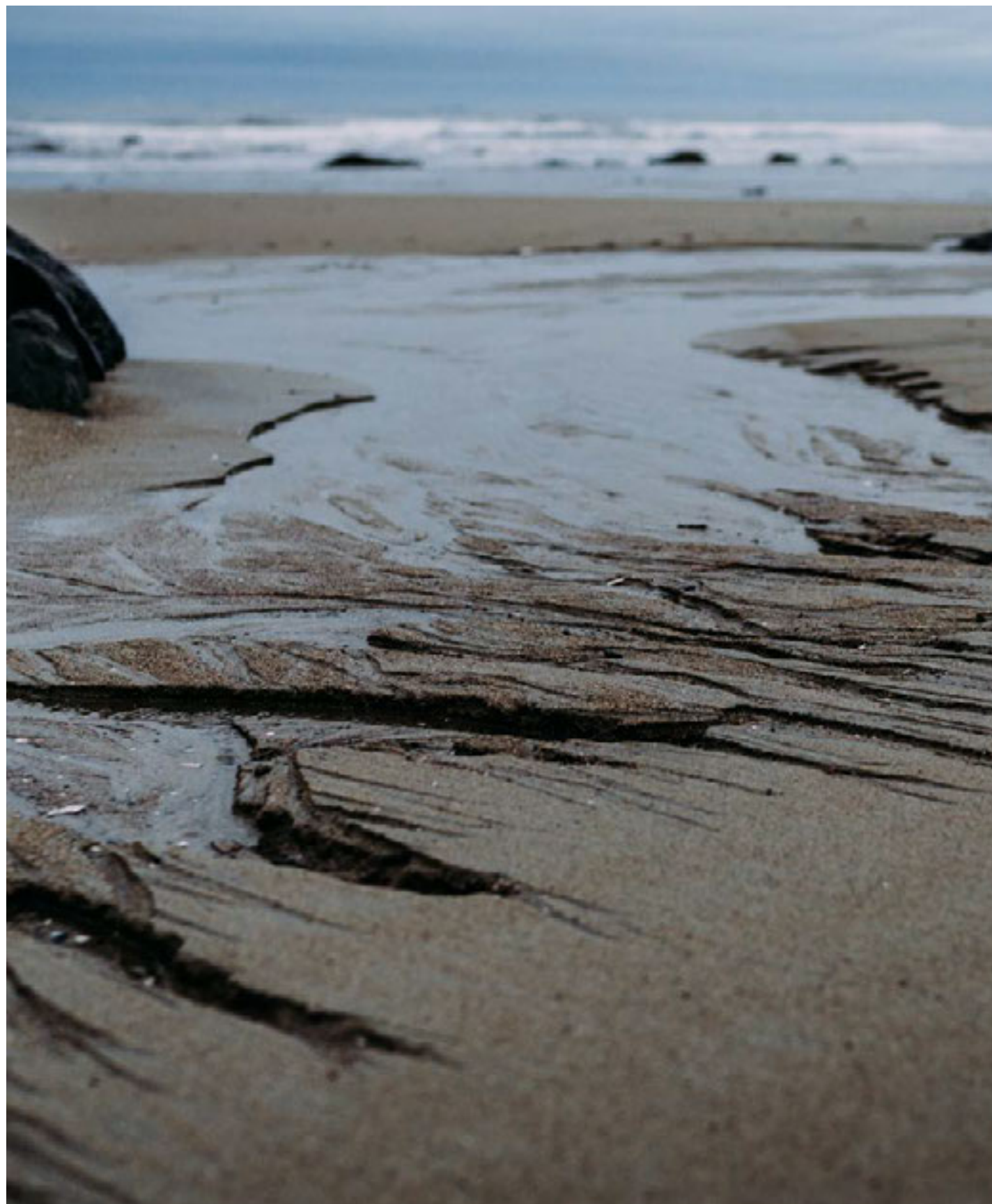

## Not perfect and perfect at the same time

Imperfecto y perfecto al mismo tiempo

The Hamptons es una colección especial donde usamos técnicas de fabricación reintroducidas de los sistemas artesanos. Por un lado, está compuesta de versiones más pequeñas de los formatos clásicos cerámicos. Además utilizamos un sistema de bicocción que nos permite reproducir craquelados a voluntad. En Carmen hemos conseguido reproducirlo sin perder ninguna de las propiedades mecánicas del material. ¡Pura esencia cerámica!

**The Hamptons is a special collection where we use production techniques reintroduced from handicrafts systems. On the one hand, it's composed of smaller versions of the classic tile formats. We also use a double firing system that allows us to reproduce a crackle glazed effect when desired. At Carmen we've managed to reproduce it without losing any of the mechanical properties of the material. Pure ceramic essence!**



The Hamptons, New York (USA).  
The Hamptons, New York (EE. UU.).



Craquelé detail of Foster Acqua Crackled.  
Detalle del craquelado de Foster Acqua Crackled.





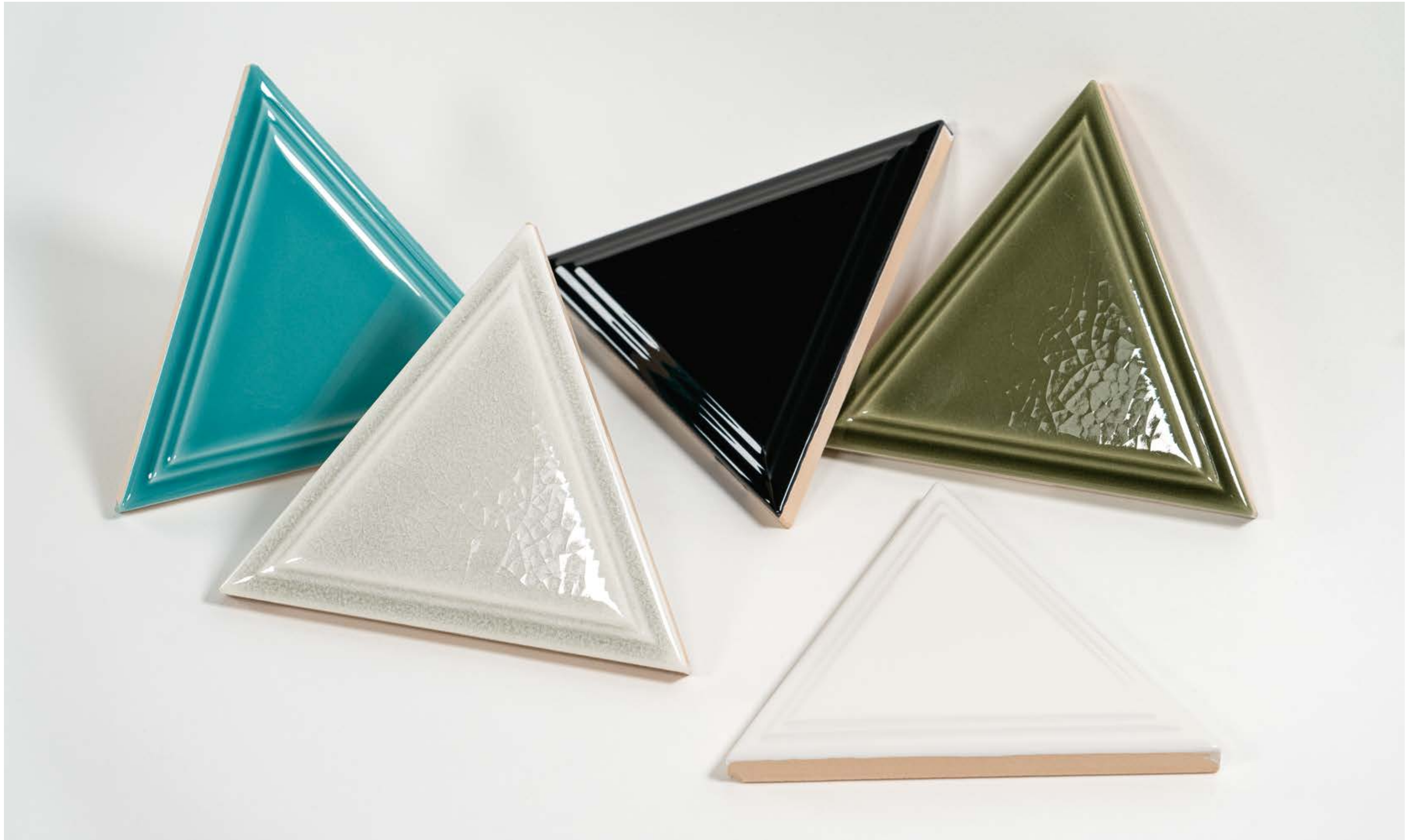



**/true tile/:**  
a ceramic tile proud of its roots.

**/true tile/:**  
una baldosa cerámica orgullosa de sus raíces.

## The Hamptons

# Kirk & Foster

11x13 cm / 4"x5"

**The triangle tile is a complement often used to round off geometric compositions that combine various shapes. It was only very recently that the triangle tile bounced back as a ceramic piece with an amazing scope for decoration. At Carmen we've revived this format to explore all its possibilities as a piece that encompasses all the beauty of tiles, showcasing its key features of format, enamel coating and colour.**

El triángulo cerámico es una pieza de complemento que usualmente servía para completar composiciones geométricas que combinaban diferentes formas. Fue muy recientemente cuando el triángulo cerámico se recuperó como una pieza cerámica con mayor calado decorativo. En Carmen recuperamos este formato para explorar todas sus posibilidades como una pieza que encierra toda la belleza de la cerámica explotando sus principales características: formato, esmalte y color.



\*Tile displayed at actual size  
Baldosa reproducida a tamaño real





KIRK SNOW  
11X13 / 4"X5" P83 / M

FOSTER SNOW CRACKLED  
11X13 / 4"X5" P84 / M

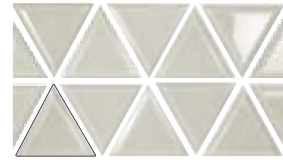

KIRK MIST  
11X13 / 4"X5" P83 / M

FOSTER MIST CRACKLED  
11X13 / 4"X5" P84 / M



KIRK SMOKE  
11X13 / 4"X5" P83 / M

FOSTER SMOKE CRACKLED  
11X13 / 4"X5" P84 / M

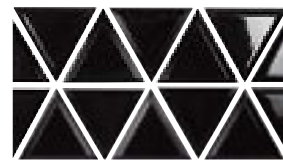

KIRK NIGHT  
11X13 / 4"X5" P83 / M

FOSTER NIGHT CRACKLED  
11X13 / 4"X5" P84 / M



KIRK ACQUA  
11X13 / 4"X5" P83 / M

FOSTER ACQUA CRACKLED  
11X13 / 4"X5" P84 / M



KIRK VICTORIAN GREEN  
11X13 / 4"X5" P83 / M

FOSTER VICTORIAN GREEN CRACKLED  
11X13 / 4"X5" P84 / M



KIRK SKY  
11X13 / 4"X5" P83 / M

FOSTER SKY CRACKLED  
11X13 / 4"X5" P84 / M



KIRK PALLADIAN  
11X13 / 4"X5" P83 / M

FOSTER PALLADIAN CRACKLED  
11X13 / 4"X5" P84 / M



KIRK PINK  
11X13 / 4"X5" P83 / M

FOSTER PINK CRACKLED  
11X13 / 4"X5" P84 / M



KIRK CHERRY  
11X13 / 4"X5" P83 / M

FOSTER CHERRY CRACKLED  
11X13 / 4"X5" P84 / M



Shine / Brillo



Shine crackled / Brillo craquelado



FOSTER SMOKE CRACKLED 11X13







# Havens & Mecox

5x15 cm / 2" x 6"

**This tile, just like the picket, traces its origins back to the *alfardón*, but multi-arched, in the desire to give it an even more decorative dimension. It's a reinterpretation of this format where more holistic forms are introduced, typical of a vision of it from the nineteenth century widely used in the English countryside style and subsequently transferred to urban civil architecture. We've revived this piece with a clear decorative spirit and a traditional style, which we've applied in both rustic and urban spaces.**

Esta pieza tiene, como el 'picket', su origen en el *alfardón*, pero con arco múltiple, en un intento de darle una dimensión más decorativa. Es una reinterpretación de este formato donde se introducen formas más organicistas, propias de una visión del mismo del siglo XIX muy utilizada en el estilo de campiña inglés y que posteriormente se trasladó a la arquitectura civil urbana. Recuperamos esta pieza con un claro espíritu decorativo y un estilo tradicional que aplicamos en espacios, tanto rústicos como urbanos.



\*Tile displayed at actual size  
Baldosa reproducida a tamaño real



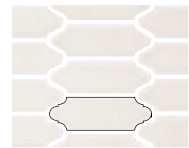

HAVENS SNOW  
5X15 / 2"X6" P79 / M

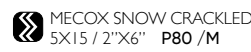

MECOX SNOW CRACKLED  
5X15 / 2"X6" P80 / M



HAVENS MIST  
5X15 / 2"X6" P79 / M

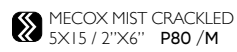

MECOX MIST CRACKLED  
5X15 / 2"X6" P80 / M



HAVENS SMOKE  
5X15 / 2"X6" P79 / M

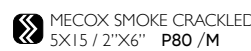

MECOX SMOKE CRACKLED  
5X15 / 2"X6" P80 / M



HAVENS NIGHT  
5X15 / 2"X6" P79 / M

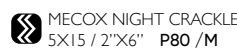

MECOX NIGHT CRACKLED  
5X15 / 2"X6" P80 / M



HAVENS ACQUA  
5X15 / 2"X6" P79 / M

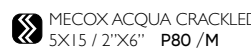

MECOX ACQUA CRACKLED  
5X15 / 2"X6" P80 / M



HAVENS VICTORIAN GREEN  
5X15 / 2"X6" P79 / M

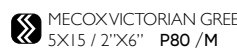

MECOX VICTORIAN GREEN CRACKLED  
5X15 / 2"X6" P80 / M



HAVENS SKY  
5X15 / 2"X6" P79 / M

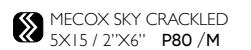

MECOX SKY CRACKLED  
5X15 / 2"X6" P80 / M

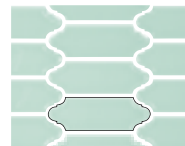

HAVENS PALLADIAN  
5X15 / 2"X6" P79 / M

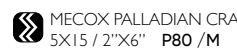

MECOX PALLADIAN CRACKLED  
5X15 / 2"X6" P80 / M

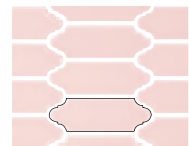

HAVENS PINK  
5X15 / 2"X6" P79 / M



MECOX PINK CRACKLED  
5X15 / 2"X6" P80 / M



HAVENS CHERRY  
5X15 / 2"X6" P79 / M

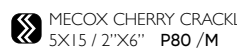

MECOX CHERRY CRACKLED  
5X15 / 2"X6" P80 / M



Shine / Brillo



Shine crackled / Brillo craquelado



HAVENS ACQUA 5X15 - CEFFO RECT. 60X120



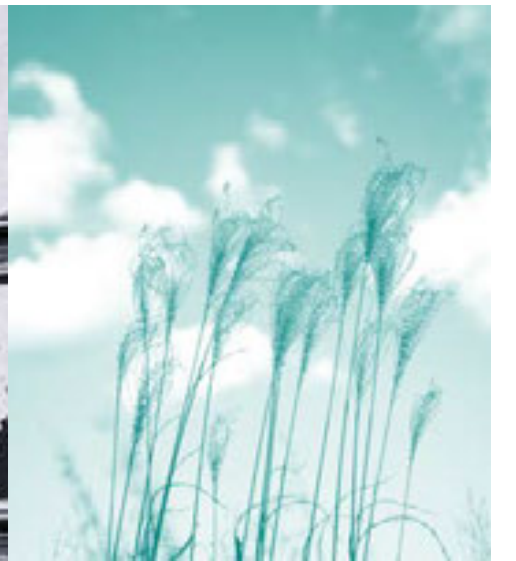

MECOX NIGHT CRACKLED 5X15



# Tiana & Orient

6,5x13 cm / 2,5"x5"

**One of the most classic formats of ceramic design. Although this is a format that has been around for centuries, it was with the arrival of the underground that it became an authentic icon of urban life. As Carmen we've retrieved this iconic design in its purest version, both in more perfected finishes and with the waves and imperfections of manual finishes, which give the design an unparalleled beauty.**

Uno de los formatos más clásicos del diseño cerámico. Aunque es un formato que ha existido desde hace siglos, fue con la llegada del metro cuando se convirtió en un verdadero icono de la vida urbana. En Carmen hemos recuperado este icono del diseño en su versión más pura, tanto en acabados más perfectos como con las ondas e imperfecciones propias de los acabados manuales, que le otorgan una belleza única al diseño.



\*Tile displayed at actual size  
Baldosa reproducida a tamaño real

# Tiana / Orient

6,5x13 / 2,5"x5"



TIANA SNOW  
6,5X13 / 2,5"X5" P81 / M

ORIENT SNOW CRACKLED  
6,5X13 / 2,5"X5" P82 / M



TIANA SMOKE  
6,5X13 / 2,5"X5" P81 / M

ORIENT SMOKE CRACKLED  
6,5X13 / 2,5"X5" P82 / M

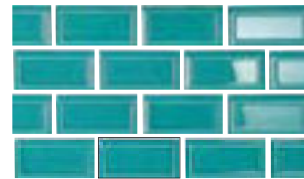

TIANA ACQUA  
6,5X13 / 2,5"X5" P81 / M

ORIENT ACQUA CRACKLED  
6,5X13 / 2,5"X5" P82 / M

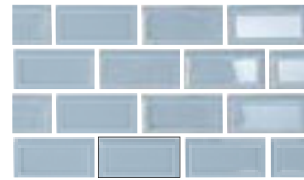

TIANA SKY  
6,5X13 / 2,5"X5" P81 / M

ORIENT SKY CRACKLED  
6,5X13 / 2,5"X5" P82 / M

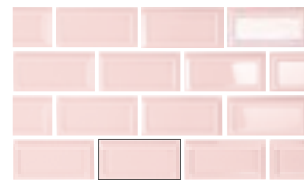

TIANA PINK  
6,5X13 / 2,5"X5" P81 / M

ORIENT PINK CRACKLED  
6,5X13 / 2,5"X5" P82 / M



TIANA MIST  
6,5X13 / 2,5"X5" P81 / M

ORIENT MIST CRACKLED  
6,5X13 / 2,5"X5" P82 / M



TIANA NIGHT  
6,5X13 / 2,5"X5" P81 / M

ORIENT NIGHT CRACKLED  
6,5X13 / 2,5"X5" P82 / M



TIANA VICTORIAN GREEN  
6,5X13 / 2,5"X5" P81 / M

ORIENT VICTORIAN GREEN CRACKLED  
6,5X13 / 2,5"X5" P82 / M

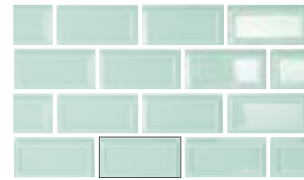

TIANA PALLADIAN  
6,5X13 / 2,5"X5" P81 / M

ORIENT PALLADIAN CRACKLED  
6,5X13 / 2,5"X5" P82 / M

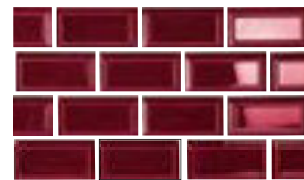

TIANA CHERRY  
6,5X13 / 2,5"X5" P81 / M

ORIENT CHERRY CRACKLED  
6,5X13 / 2,5"X5" P82 / M



Shine / Brillo



Shine crackled / Brillo craquelado



TIANA SMOKE 6,5X13 - WORK B CENERE RECT. 30X60





ORIENT MIST CRACKLED 6,5X13

# Gin & Cooper

5x18 cm / 2" x 7"

**The picket or lozenge is one of the on-trend tile formats today. Despite its modern appearance, it's a contemporary take on a classic tile. Its ancestor is the *alfardón*, which dates back to the twelfth century.**

**At Carmen we wanted to revive this cousin of the hexagon tile with a more elongated version that gives it a stylised look.**

El 'picket' o losanga es uno de los formatos cerámicos de tendencia. A pesar de su aspecto moderno, se trata de una versión contemporánea de un clásico de la cerámica. Su antepasado es el *alfardón*, cuyo origen se remonta al siglo XII. En Carmen hemos querido recuperar este primo hermano del hexágono con una versión más alargada que le da un aspecto estilizado.



\*Tile displayed at actual size  
Baldosa reproducida a tamaño real



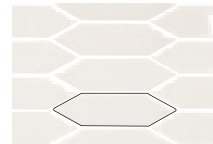

GIN SNOW  
5x18 / 2"x7" P85 / M



COOPER SNOW CRACKLED  
5x18 / 2"x7" P86 / M

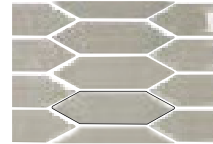

GIN SMOKE  
5x18 / 2"x7" P85 / M

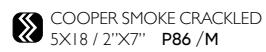

COOPER SMOKE CRACKLED  
5x18 / 2"x7" P86 / M

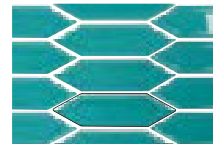

GIN ACQUA  
5x18 / 2"x7" P85 / M

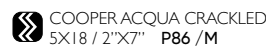

COOPER ACQUA CRACKLED  
5x18 / 2"x7" P86 / M

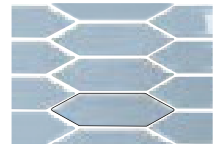

GIN SKY  
5x18 / 2"x7" P85 / M

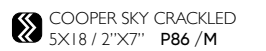

COOPER SKY CRACKLED  
5x18 / 2"x7" P86 / M

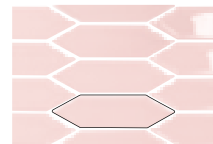

GIN PINK  
5x18 / 2"x7" P85 / M



COOPER PINK CRACKLED  
5x18 / 2"x7" P86 / M

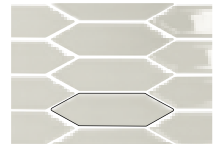

GIN MIST  
5x18 / 2"x7" P85 / M

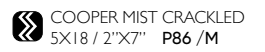

COOPER MIST CRACKLED  
5x18 / 2"x7" P86 / M

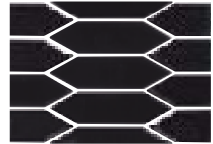

GIN NIGHT  
5x18 / 2"x7" P85 / M



COOPER NIGHT CRACKLED  
5x18 / 2"x7" P86 / M

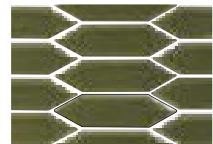

GIN VICTORIAN GREEN  
5x18 / 2"x7" P85 / M



COOPER VICTORIAN GREEN CRACKLED  
5x18 / 2"x7" P86 / M

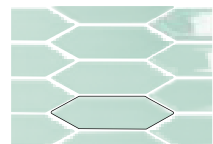

GIN PALLADIAN  
5x18 / 2"x7" P85 / M



COOPER PALLADIAN CRACKLED  
5x18 / 2"x7" P86 / M



GIN CHERRY  
5x18 / 2"x7" P85 / M



COOPER CHERRY CRACKLED  
5x18 / 2"x7" P86 / M



Shine / Brillo



Shine cracked / Brillo craquelado



COOPER PINK CRACKLED 5x18







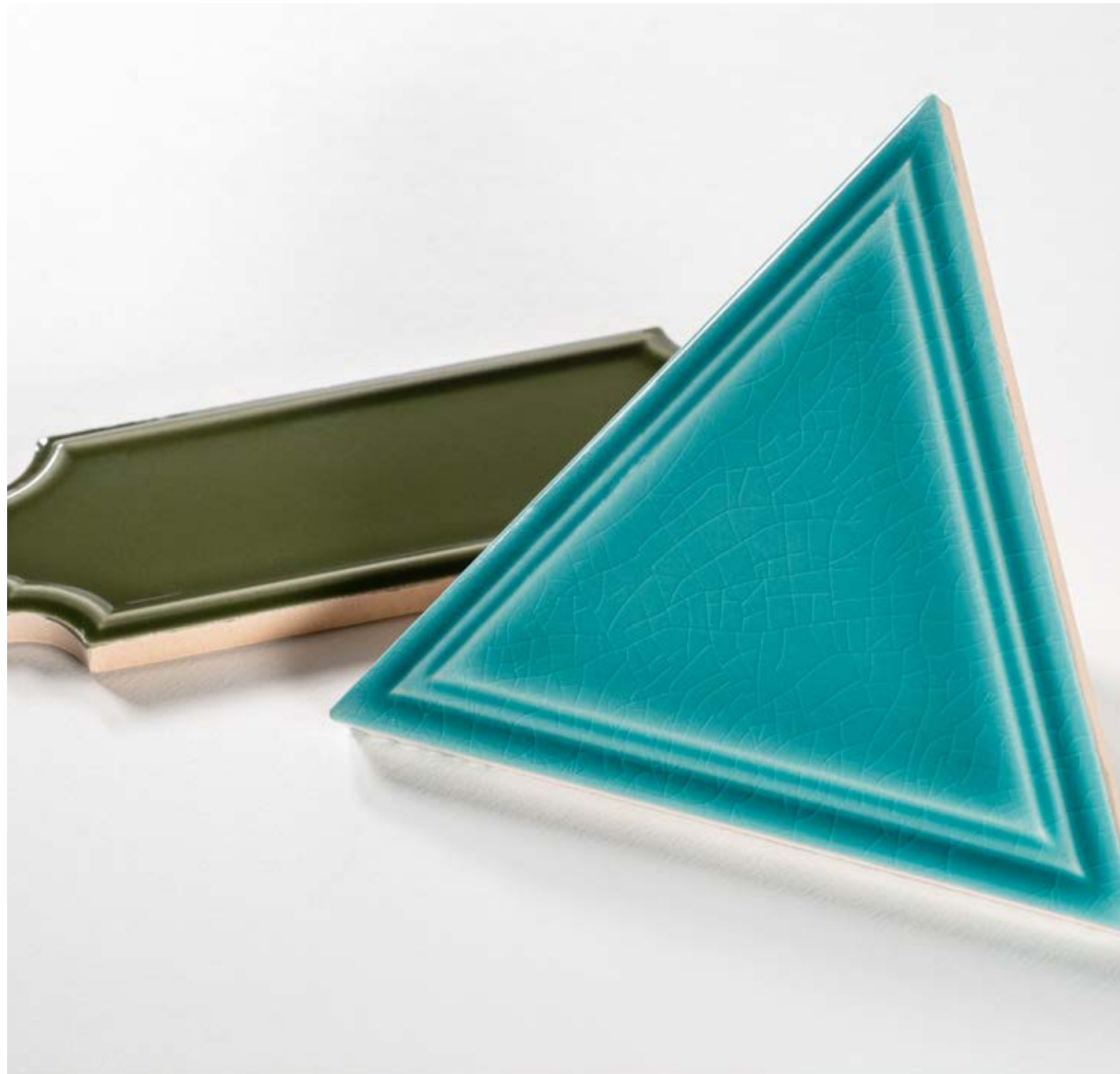

GIN PALLADIAN 5X18 - OH LA LA WHITE RECT. 40X120





Technical characteristics & packing · Características técnicas y embalaje

-  WHITE BODY / PASTA BLANCA
-  SHINE / BRILLO
-  THICKNESS 0.3" / ESPESOR 8MM
-  WALL TILE / REVESTIMIENTO
-  UNIFORM APPEARANCE / ASPECTO UNIFORME

Size Formato	Tiles/box Pzs/caja	Sqm/box M2/caja	Kg/box Kg/caja	Boxes/pallet Cajas/pallet	Sqm/pallet M2/pallet	Kg/pallet Kg/pallet
11x13	66	0,99	9,29	56	55,26	520
5x15	80	0,60	6,48	98	58,80	635
6,5x13	56	0,47	7,42	100	47,32	742
5x18	72	0,65	6,60	96	62,21	633



# CARMEN

true tiles

Ciudad del Transporte  
C/ Luxemburgo, 46  
12006 Castellón (Spain)

Ape Italia Srl  
Via Carazzoli, n° 17-19  
Fiorano Modenese (Modena)  
Italia

T. +34 964 340 434  
apegrupo@apegrupo.com  
apegrupo.com

The reproduction of the colors is approximate. Carmen reserves the right to alter or amend the products here stated.  
La reproducción de los colores es aproximada. Carmen se reserva el derecho de alterar o modificar los productos aquí relacionados.

Price codes and product codes should be checked, since there may be typographical errors. Touch always recommend consulting the Touchsite as the products could undergo price code, format or packing changes.  
Los códigos de precios y referencias deben verificarse ya que puede haber errores tipográficos. Es recomendable consultar la Touchb ya que cualquier producto de este catálogo puede sufrir cambios en códigos de venta, formatos o packing.

On the Touchsite you can also find the technical specifications, installation suggestions, merchandising elements and a variety of room scene pictures for each of the inspirations.  
En la Touchb también pueden consultar las características técnicas, consejos de colocación, elementos de merchandising o los diversos ambientes de cada una de las colecciones.

**Carmen**

**Ciudad del Transporte  
C/ Luxemburgo, 46  
12006 Castellón (Spain)**

**Ape Italia Srl  
Via Carazzoli, 17-19  
Fiorano Modenese, Modena  
(Italy)**

**T. +34 964 340 434  
apegrupo@apegrupo.com  
apegrupo.com**

**ape**grupo