

# WATERFALL

**MATERIA MUTEVOLE**  
*VARIABLE MATERIAL*



**LEA**

CERAMICHE

SUPERFICIE  
AD EFFETTO  
PIETRA.

Surface  
with a stone  
effect.



# WATERFALL

**4 COLORI**  
ivory flow  
silver flow  
gray flow  
dark flow

**4 COLORS**  
*ivory flow*  
*silver flow*  
*gray flow*  
*dark flow*

**3 FINITURE**  
lappata  
naturale  
grip

**3 FINISHES**  
*lappata*  
*naturale*  
*grip*

**5 FORMATI**  
90x90cm  
60x120cm  
45x90cm  
60x60cm  
30x60cm

**5 SIZES**  
36"x36"  
24"x48"  
18"x36"  
24"x24"  
12"x24"



**IVORY FLOW**

90x90cm / 36"x36"  
naturale rett.

Waterfall rilegge in modo realistico e fisico una pietra rocciosa e antica come l'ardesia. Ricreando sulla superficie del grès gli effetti cangianti tipici delle pietre rocciose sedimentarie, Waterfall registra texture, irregolarità e variazioni di colori, espressioni puntuali del trascorrere del tempo.

Waterfall realistically and physically represents slate, an ancient and natural stone. Recreating, on the stoneware surface the iridescence typical of sedimentary rocks, Waterfall has texture, irregularities, and variations in colour, typical expressions of the passage of time.

## DARK FLOW

**Parete / Wall**  
30x60cm / 12"x24"  
lappata rett.  
**mosaico 36**  
30x30cm / 12"x12"  
**Pavimento / Floor**  
60x60cm / 24"x24"  
lappata rett.



**DARK FLOW**

30x60cm / 12"x24"  
lappata rett.



**BASKET**

**GRAMMA 66  
DARK FLOW**

39,2x19,5cm / 15<sup>3</sup>/<sub>8</sub>"x7<sup>5</sup>/<sub>8</sub>"  
naturale

**GRAMMA 16  
SILVER FLOW**

19,5x9,7cm / 7<sup>5</sup>/<sub>8</sub>"x3<sup>3</sup>/<sub>4</sub>"  
naturale

**TWIST**

**GRAMMA 66  
GRAY FLOW**

39,2x19,5cm / 15<sup>3</sup>/<sub>8</sub>"x7<sup>5</sup>/<sub>8</sub>"  
naturale





## ARROW

---

**GRAMMA 66**  
**DARK FLOW**  
**SILVER FLOW**  
39,2x19,5cm / 15<sup>3</sup>/<sub>8</sub>"x7<sup>5</sup>/<sub>8</sub>"  
naturale

Le cromie, di base grigie, spaziano dalla tonalità più scura, il Dark Flow, a quella più chiara, Ivory Flow, richiamando il naturale processo di ossidazione della pietra, materia in continua trasformazione che cambia colore, forma e struttura, adattandosi all'evolversi dei fenomeni naturali.

The colours, in grey scale, vary from the darkest tone, Dark Flow, to the lightest, Ivory Flow, recalling the natural oxidation process of the stone, a material that is under continuous transformation, changing colour, shape, and structure, and adapting itself to the evolution of natural phenomenon.



CHEVRON

GRAMMA 72  
GRAY FLOW  
49,8x16,9cm / 19 1/2"x6 5/8"  
naturale

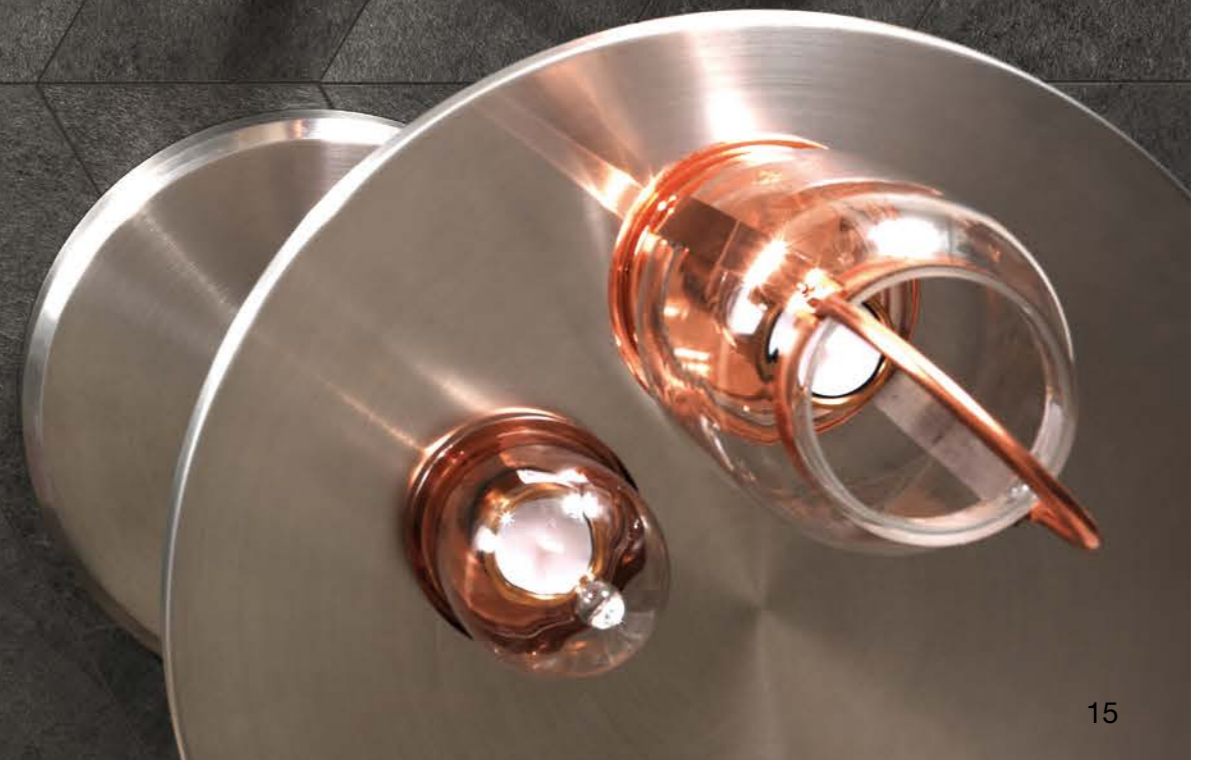

## IVORY FLOW

muretto 3D  
30x60cm / 12"x24"  
lappata rett.





## IVORY FLOW

**Parete / Wall**  
muretto 3D  
30x60cm / 12"x24"  
lappata rett.

**Pavimento / Floor**  
90x90cm / 36"x36"  
naturale rett.





La ricerca di Lea Ceramiche è andata oltre, adoperandosi non solo a restituire un materiale dalle qualità prestazionali indiscutibili, ma riuscendo a conferire una stratigrafia più complessa.

Con l'inclusione di altre tipologie di pietre come le quarziti brasiliane, si è arrivati ad una perfetta definizione estetica, un'armonizzazione grafica che conferisce alla materia eleganza e che interagisce col mutare della luce.

Lea Ceramiche's research went above and beyond, striving not only to create a material of indisputably high quality, but also successfully lending it a more complex stratigraphy.

With the inclusion of other types of stone, like Brazilian quartzite, the perfect aesthetic definition has been achieved, a graphic harmony that gives elegance to the material and that interacts with the changing light.

## SILVER FLOW

muretto  
30x60cm / 12"x24"  
lappata rett.



**SILVER FLOW**

muretto  
30x60cm / 12"x24"  
lappata rett.

**DARK FLOW**

60x60cm / 24"x24"  
lappata rett.

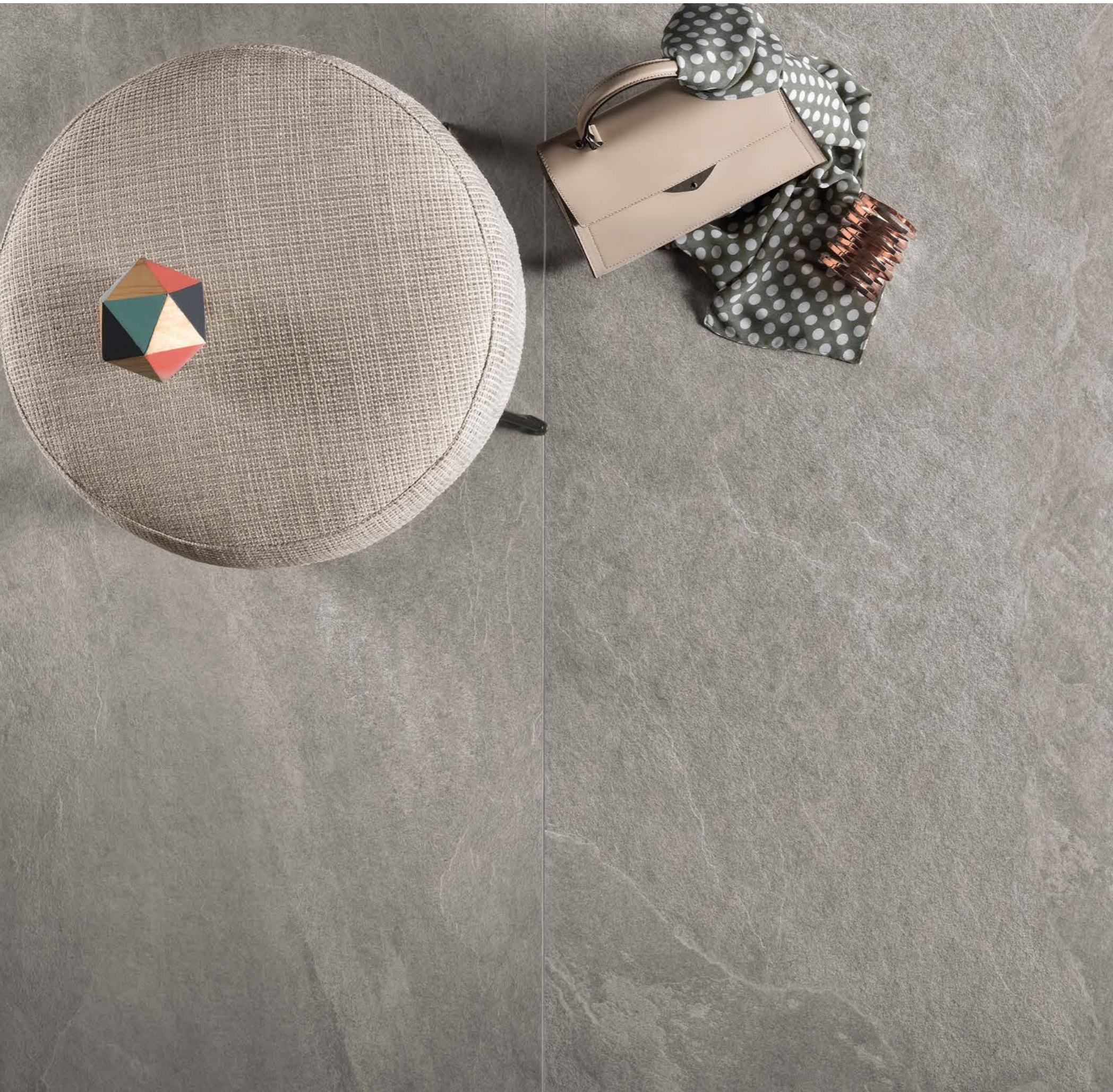

SILVER FLOW

60x120cm / 24"x48"  
naturale rett.

**IVORY FLOW**

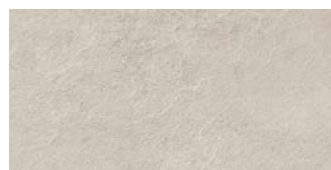

30x60cm / 12"x24"  
lapp. rett. (spessore 10,5mm) LGVWFX2



60x60cm / 24"x24"  
lapp. rett. (spessore 10,5mm) LGVWFX2  
nat. rett. (spessore 10,5mm) LGVWFN2  
\*grip rett. (spessore 10,5mm) LGVWF20



45x90cm / 18"x36"  
lapp. rett. (spessore 10,5mm) LGGWFX2  
nat. rett. (spessore 10,5mm) LGGWFN2



90x90cm / 36"x36"  
lapp. rett. (spessore 10,5mm) LG9WFX2  
nat. rett. (spessore 10,5mm) LG9WF20



60x120cm / 24"x48"  
lapp. rett. (spessore 10,5mm) LGXWFX2  
nat. rett. (spessore 10,5mm) LGXWF20

**SILVER FLOW**

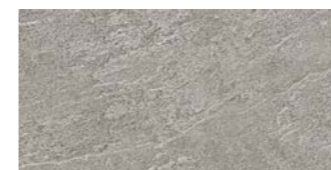

30x60cm / 12"x24"  
lapp. rett. (spessore 10,5mm) LGVWFX3



60x60cm / 24"x24"  
lapp. rett. (spessore 10,5mm) LGVWFX3  
nat. rett. (spessore 10,5mm) LGVWFN3  
\*grip rett. (spessore 10,5mm) LGVWF30



45x90cm / 18"x36"  
lapp. rett. (spessore 10,5mm) LGGWFX3  
nat. rett. (spessore 10,5mm) LGGWFN3



90x90cm / 36"x36"  
lapp. rett. (spessore 10,5mm) LG9WFX3  
nat. rett. (spessore 10,5mm) LG9WF30



60x120cm / 24"x48"  
lapp. rett. (spessore 10,5mm) LGXWFX3  
nat. rett. (spessore 10,5mm) LGXWF30

\*non trattato con antibatterico  
without antimicrobial treatment  
sans traitement antibacterien  
nicht mit antibakterieller  
Wirkung ausgestattet



**GRAY FLOW**



30x60cm / 12"x24"  
lapp. rett. (spessore 10,5mm) LGVWFX1



60x60cm / 24"x24"  
lapp. rett. (spessore 10,5mm) LGWWFX1  
nat. rett. (spessore 10,5mm) LGWWFNI  
\*grip rett. (spessore 10,5mm) LGWWF10

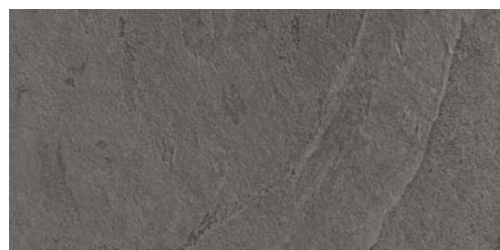

45x90cm / 18"x36"  
lapp. rett. (spessore 10,5mm) LGGWFX1  
nat. rett. (spessore 10,5mm) LGGWFNI

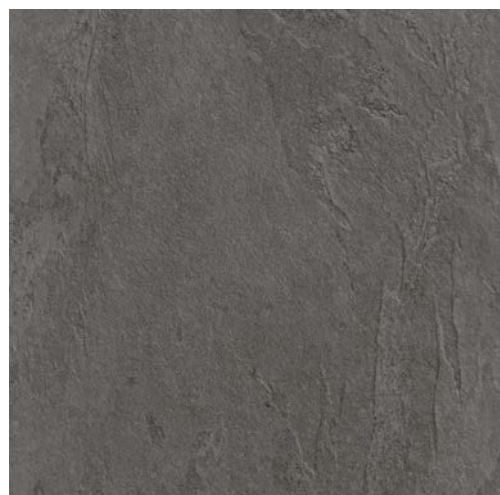

90x90cm / 36"x36"  
lapp. rett. (spessore 10,5mm) LG9WFX1  
nat. rett. (spessore 10,5mm) LG9WF10

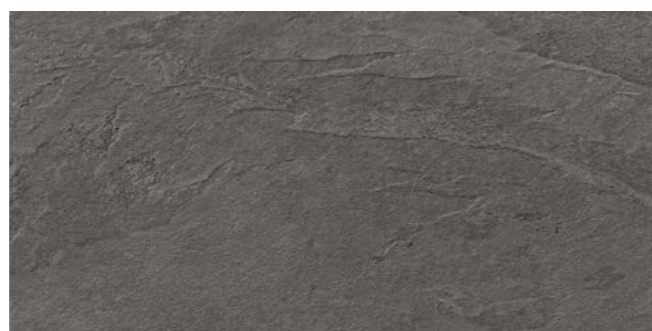

60x120cm / 24"x48"  
lapp. rett. (spessore 10,5mm) LGXWFX1  
nat. rett. (spessore 10,5mm) LGXWF10

**DARK FLOW**

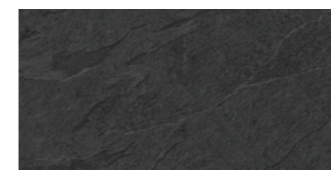

30x60cm / 12"x24"  
lapp. rett. (spessore 10,5mm) LGVWFX0

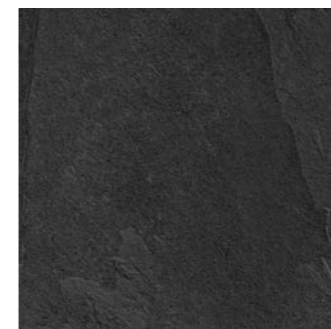

60x60cm / 24"x24"  
lapp. rett. (spessore 10,5mm) LGWWFX0  
nat. rett. (spessore 10,5mm) LGWWFNO  
\*grip rett. (spessore 10,5mm) LGWWF00

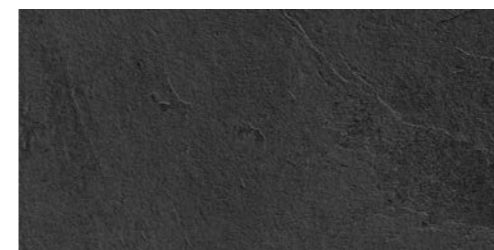

45x90cm / 18"x36"  
lapp. rett. (spessore 10,5mm) LGGWFX0  
nat. rett. (spessore 10,5mm) LGGWFNO

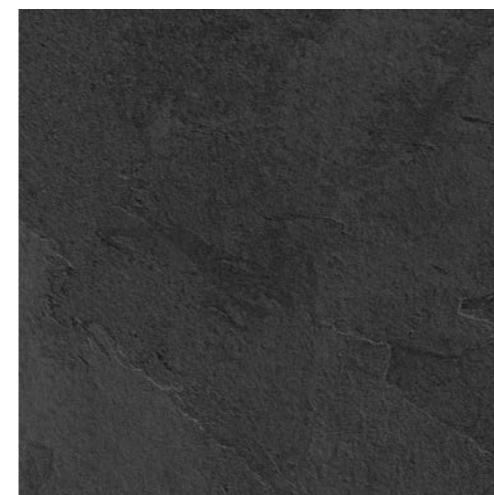

90x90cm / 36"x36"  
lapp. rett. (spessore 10,5mm) LG9WFX0  
nat. rett. (spessore 10,5mm) LG9WF00

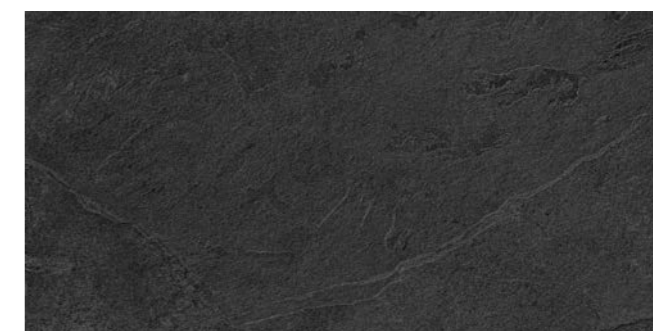

60x120cm / 24"x48"  
lapp. rett. (spessore 10,5mm) LGXWFX0  
nat. rett. (spessore 10,5mm) LGXWF00

\*non trattato con antibatterico  
without antimicrobial treatment  
sans traitement antibacterien  
nicht mit antibakterieller  
Wirkung ausgestattet

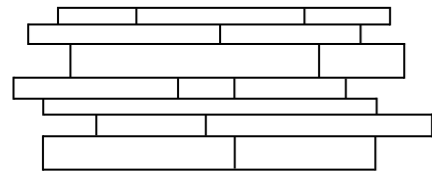

**MURETTO**  
30x60cm / 12"x24"  
ivory flow lapp.  
silver flow lapp.  
gray flow lapp.  
dark flow lapp.

LG9WFM2  
LG9WFM3  
LG9WFM1  
LG9WFM0

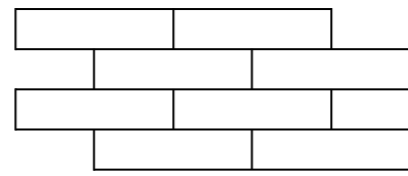

**BRICK**  
30x60cm / 12"x24"  
ivory flow lapp.  
silver flow lapp.  
gray flow lapp.  
dark flow lapp.

LGVWF20  
LGVWF30  
LGVWF10  
LGVWF00

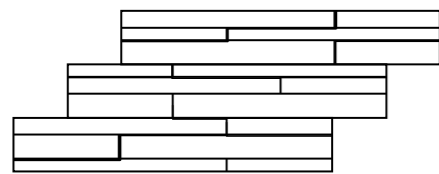

**MURETTO 3D**  
30x60cm / 12"x24"  
ivory flow lapp.  
silver flow lapp.  
gray flow lapp.  
dark flow lapp.

LGVWFD2  
LGVWFD3  
LGVWFD1  
LGVWFD0

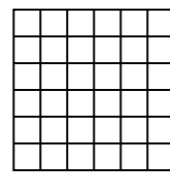

**MOSAICO 36**  
30x30cm / 12"x12"  
ivory flow lapp.  
silver flow lapp.  
gray flow lapp.  
dark flow lapp.

LGCWF20  
LGCWF30  
LGCWF10  
LGCWF00

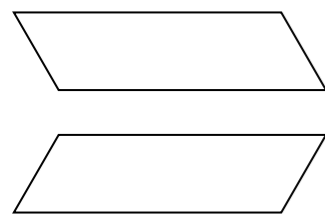

**GRAMMA 72**  
49,8x16,9cm / 19 1/2"x6 5/8"  
ivory flow nat.  
silver flow nat.  
gray flow nat.  
dark flow nat.

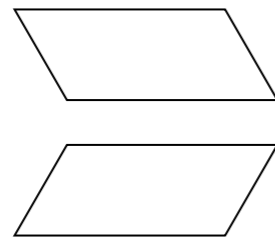

**GRAMMA 66**  
39,2x19,5cm / 15 3/8"x7 5/8"  
ivory flow nat.  
silver flow nat.  
gray flow nat.  
dark flow nat.



**GRAMMA 16**  
19,5x9,7cm / 7 5/8"x3 3/4"  
ivory flow nat.  
silver flow nat.  
gray flow nat.  
dark flow nat.

**BASKET / Gramma 66 - Gramma 16**

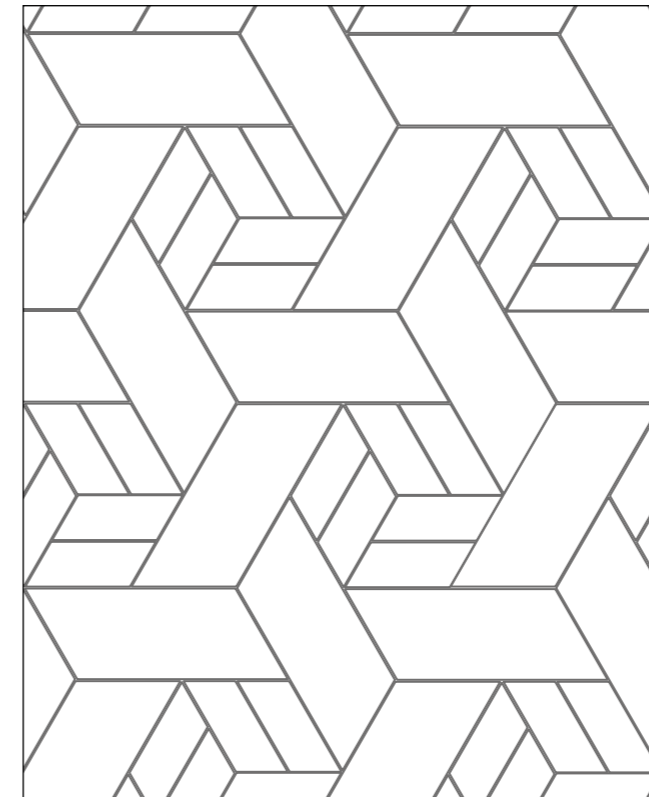

**TWIST / Gramma 66**

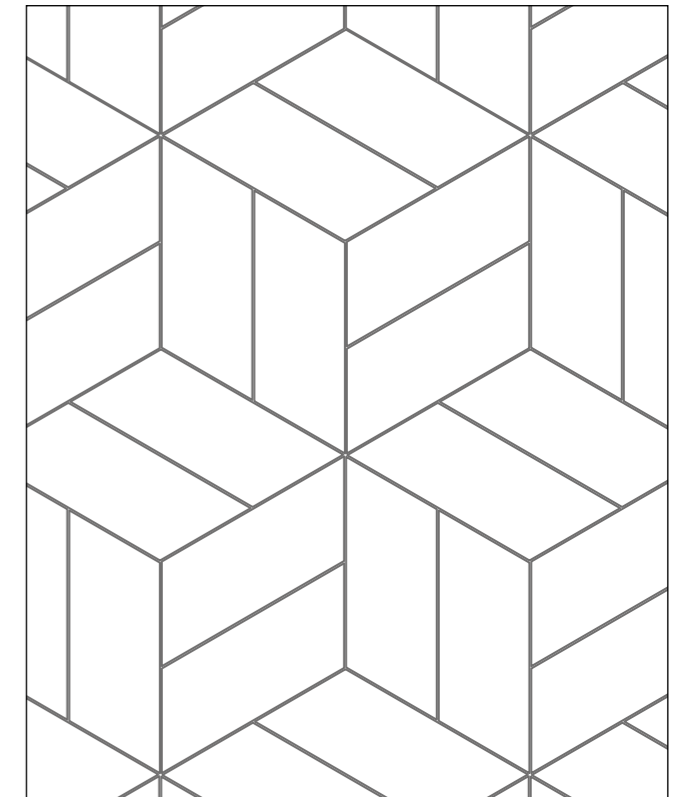

**CHEVRON / Gramma 72**

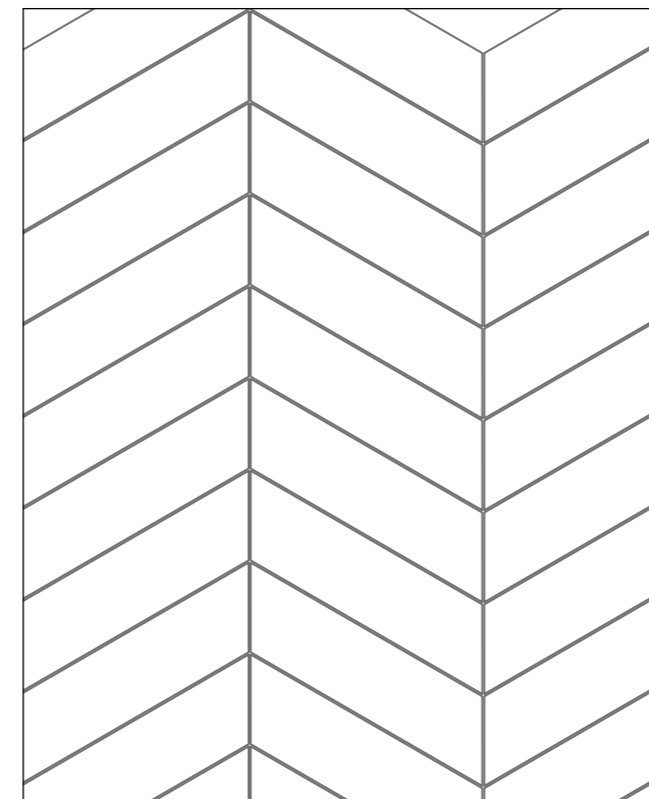

**ARROW / Gramma 66**

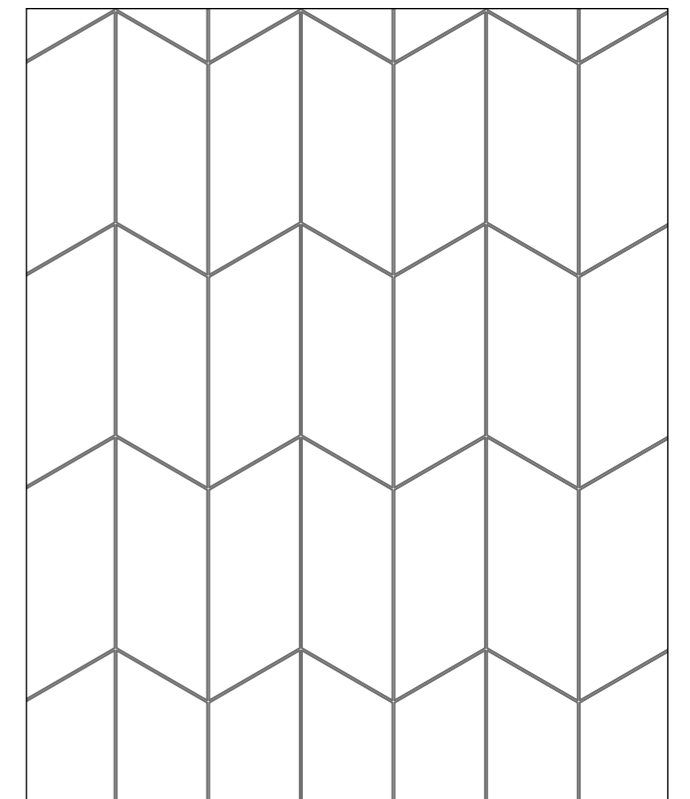

**LAPPATA**

**ANGOLO SX GRADINO PLUS lapp. rett.\***  
35x120cm / 13<sup>3/4</sup>"x48"  
ivory flow LG8WF72  
silver flow LG8WF82  
gray flow LG8WF62  
dark flow LG8WF52

**GRADINO PLUS lapp. rett.\***  
35x120cm / 13<sup>3/4</sup>"x48"  
ivory flow LG8WF70  
silver flow LG8WF80  
gray flow LG8WF60  
dark flow LG8WF50

**ANGOLO DX GRADINO PLUS lapp. rett.\***  
35x120cm / 13<sup>3/4</sup>"x48"  
ivory flow LG8WF71  
silver flow LG8WF81  
gray flow LG8WF61  
dark flow LG8WF51

**BATTISCOPA lapp. rett.**  
10x60cm / 4"x24"  
ivory flow LGBWFL2  
silver flow LGBWFL3  
gray flow LGBWFL1  
dark flow LGBWFLO

**NATURALE**

**ANGOLO SX GRADINO PLUS nat. rett.\***  
35x120cm / 13<sup>3/4</sup>"x48"  
ivory flow LG8WF22  
silver flow LG8WF32  
gray flow LG8WF12  
dark flow LG8WF02

**GRADINO PLUS nat. rett.\***  
35x120cm / 13<sup>3/4</sup>"x48"  
ivory flow LG8WF20  
silver flow LG8WF30  
gray flow LG8WF10  
dark flow LG8WF00

**ANGOLO DX GRADINO PLUS nat. rett.\***  
35x120cm / 13<sup>3/4</sup>"x48"  
ivory flow LG8WF21  
silver flow LG8WF31  
gray flow LG8WF11  
dark flow LG8WF01

**BATTISCOPA nat. rett.**  
10x60cm / 4"x24"  
ivory flow LGBWFN2  
silver flow LGBWFN3  
gray flow LGBWFN1  
dark flow LGBWFNO

**GRIP**

**ANGOLO GRADINO PLUS grip rett.\***  
35x35cm / 13<sup>3/4</sup>"x13<sup>3/4</sup>"  
ivory flow LG2WF21  
silver flow LG2WF31  
gray flow LG2WF11  
dark flow LG2WF01

**GRADINO PLUS grip rett.\***  
35x60cm / 13<sup>3/4</sup>"x24"  
ivory flow LG2WF20  
silver flow LG2WF30  
gray flow LG2WF10  
dark flow LG2WF00

**SEZIONE GRADINO**

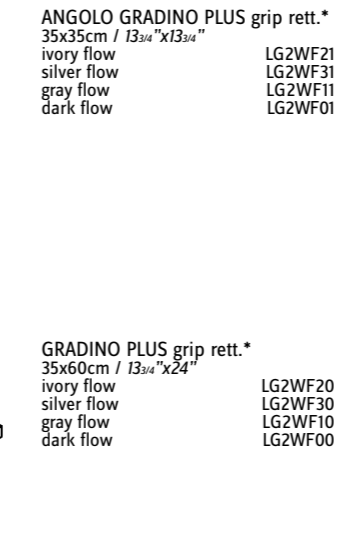
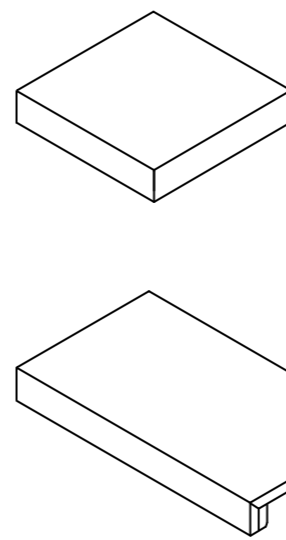
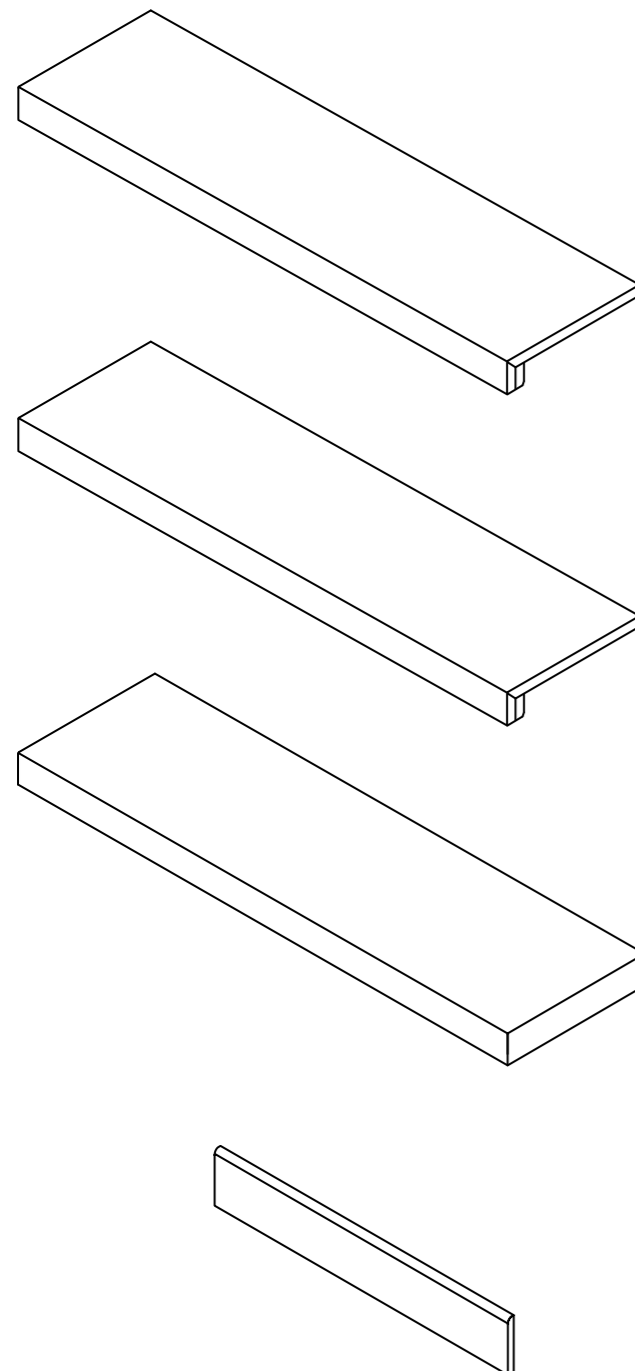
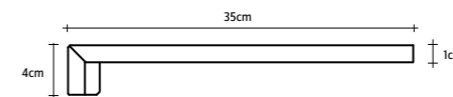

\*su richiesta. Per maggiori informazioni circa quantità minime e tempi di consegna rivolgersi all'ufficio commerciale.  
upon request. For more information about minimum quantities and delivery times please contact the sales department.  
sur demande. Pour plus d'informations sur les quantités minimales et délais de livraison s'il vous plaît contacter le département des ventes.  
auf Anfrage. Für weitere Infos über die Mindestmengen und Lieferzeiten wenden Sie sich bitte an unserer Verkaufsabteilung.

## FORMATI E COLORI 20mm

SIZES AND COLORS 20mm\_FORMATS ET COULEURS 20mm\_FORMATE UND FARBEN 20mm

### IVORY FLOW



45x90cm / 18"x36"  
rett. (spessore 20mm)

LGGK220

### SILVER FLOW



45x90cm / 18"x36"  
rett. (spessore 20mm)

LGGK230

### GRAY FLOW

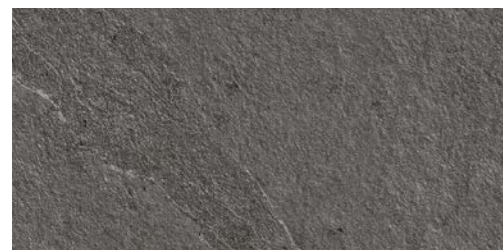

45x90cm / 18"x36"  
rett. (spessore 20mm)

LGGK210

### DARK FLOW

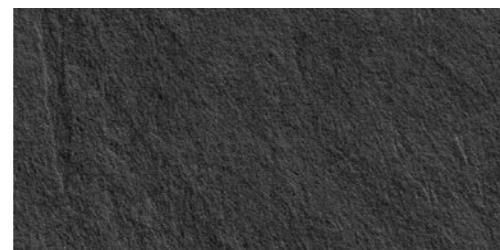

45x90cm / 18"x36"  
rett. (spessore 20mm)

LGGK200

## PEZZI SPECIALI 20mm

TRIMS 20mm\_PIECES SPÉCIALES 20mm\_FORMSTÜCKE 20mm

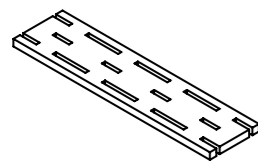

GRIGLIA rett.\*  
15x45cm / 6"x18"  
ivory flow  
silver flow  
gray flow  
dark flow

LGDK2Z2  
LGDK2Z3  
LGDK2Z1  
LGDK2Z0

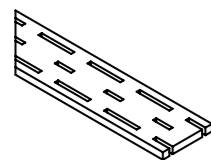

GRIGLIA ANGOLARE SX rett.\*  
15x45cm / 6"x18"  
ivory flow  
silver flow  
gray flow  
dark flow

LGDK2A5  
LGDK2A7  
LGDK2A3  
LGDK2A1

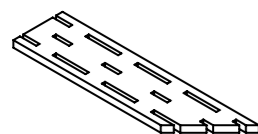

GRIGLIA ANGOLARE DX rett.\*  
15x45cm / 6"x18"  
ivory flow  
silver flow  
gray flow  
dark flow

LGDK2A4  
LGDK2A6  
LGDK2A2  
LGDK2A0

## PEZZI SPECIALI 20mm

TRIMS 20mm\_PIECES SPÉCIALES 20mm\_FORMSTÜCKE 20mm

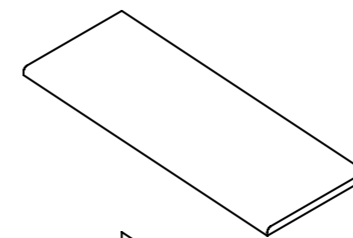

COSTA TORO rett.\*  
30x90cm / 12"x36"  
ivory flow  
silver flow  
gray flow  
dark flow

LGFK2F2  
LGFK2F3  
LGFK2F1  
LGFK2F0

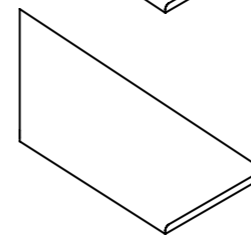

COSTA TORO ANGOLARE SX rett.\*  
30x90cm / 12"x36"  
ivory flow  
silver flow  
gray flow  
dark flow

LGFK2K5  
LGFK2K7  
LGFK2K3  
LGFK2K1

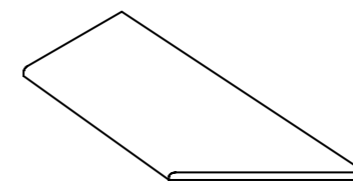

COSTA TORO ANGOLARE DX rett.\*  
30x90cm / 12"x36"  
ivory flow  
silver flow  
gray flow  
dark flow

LGFK2K4  
LGFK2K6  
LGFK2K2  
LGFK2K0

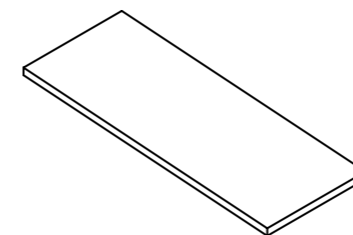

COSTA RETTA rett.\*  
30x90cm / 12"x36"  
ivory flow  
silver flow  
gray flow  
dark flow

LGFK2C2  
LGFK2C3  
LGFK2C1  
LGFK2C0

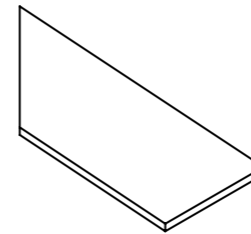

COSTA RETTA ANGOLARE SX rett.\*  
30x90cm / 12"x36"  
ivory flow  
silver flow  
gray flow  
dark flow

LGFK2D5  
LGFK2D7  
LGFK2D3  
LGFK2D1

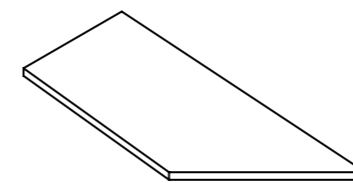

COSTA RETTA ANGOLARE DX rett.\*  
30x90cm / 12"x36"  
ivory flow  
silver flow  
gray flow  
dark flow

LGFK2D4  
LGFK2D6  
LGFK2D2  
LGFK2D0

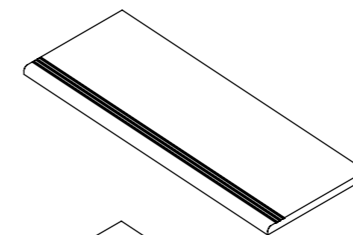

COSTA TORO STEP rett.\*  
30x90cm / 12"x36"  
ivory flow  
silver flow  
gray flow  
dark flow

LGFK2J2  
LGFK2J3  
LGFK2J1  
LGFK2J0

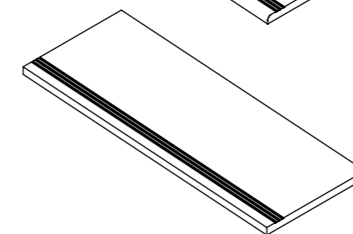

COSTA RETTA STEP rett.\*  
30x90cm / 12"x36"  
ivory flow  
silver flow  
gray flow  
dark flow

LGFK2G2  
LGFK2G3  
LGFK2G1  
LGFK2G0

\*su richiesta. Per maggiori informazioni circa quantità minime e tempi di consegna rivolgersi all'ufficio commerciale.  
upon request. For more information about minimum quantities and delivery times please contact the sales department.  
sur demande. Pour plus d'informations sur les quantités minimales et délais de livraison s'il vous plaît contacter le département des ventes.  
auf Anfrage. Für weitere Infos über die Mindestmengen und Lieferzeiten wenden Sie sich bitte an unserer Verkaufsabteilung.

## WATERFALL

gres tutta massa UGL  
full-body porcelain UGL

spessore 10,5mm / 20mm  
thickness

CONFORME  
ACCORDING TO:  
ISO 13006 G - EN 14411 G - B1a UGL  
ANSI A137.1 - UNGLAZED PORCELAIN TILES CLASS P1

CARATTERISTICA TECNICA TECHNICAL FEATURES	metodo di prova test method	requisiti prescritti required values	valori medi average values
assorbimento d'acqua water absorption	ISO 10545-3 ASTM C373	≤ 0,5%	0,05%
sforzo di rottura (S) breaking strength	ISO 10545-4 ASTM C648	≥ 1300 N ≥ 250 lbf	2500 N (10,5mm) 13600 N (20mm) 600 lbf (10,5mm) 2800 lbf (20mm)
resistenza a flessione modulus of rupture	ISO 10545-4 ASTM C1505	≥ 35 N/mm <sup>2</sup> no provision	≥ 50 N/mm <sup>2</sup> ≥ 6500 PSI
resistenza all'abrasione profonda deep abrasion resistance	ISO 10545-6 ASTM C1243	≤ 175 mm <sup>3</sup>	≤ 145 mm <sup>3</sup>
dilatazione termica lineare linear thermal expansion	ISO 10545-8 ASTM C372	requisito non previsto no provision	$\alpha \leq 7 \cdot 10^{-6} \text{ } ^\circ\text{C}^{-1}$ $\alpha \leq 4.4 \cdot 10^{-6} \text{ } ^\circ\text{F}^{-1} / \alpha \leq 8 \cdot 10^{-6} \text{ } ^\circ\text{C}^{-1}$
resistenza alle macchie stain resistance	ISO 10545-14 ASTM C1378	Classe / Class 3 Min. as indicated by manufacturer	5 RESISTENTE / RESISTANT A RESISTANT
resistenza all'attacco chimico* chemical resistance*	ISO 10545-13 ASTM C650	come indicato dal produttore as indicated by manufacturer	ULA - UHA RESISTENTE / RESISTANT A RESISTANT
resistenza al gelo frost resistance	ISO 10545-12 ASTM C1026	nessuna alterazione / no alteration as indicated by manufacturer	RESISTENTE / RESISTANT RESISTANT
resistenza allo scivolamento slip resistance	DIN 51130 DIN 51097 BCR-TORTUS ANSI A137.1 AS-NZS 4586	- - - DCOF ≥ 0.42 -	R10 (nat.) / R11 (grip - 20mm) B (A+B) (nat.) / C (A+B+C) (grip - 20mm) $\mu > 0,40$ (nat. - grip - 20mm) DCOF ≥ 0.42 (nat. - grip - 20mm) P4 (W) (grip - 20mm)
reazione al fuoco - fire reaction flame spread	EN 13823 EN 9239-1 ASTM E84	CPR (UE) 305/2011, 2000/147/CE, UNI EN 13501-1 -	Classe / Class A1 (wall) Classe / Class A1 <sub>f</sub> (floor) Class A
robinson floor tester	ASTM C627	come indicato dal produttore as indicated by manufacturer	≥ 14 cycles Extra Heavy Commercial (over concrete)
conducibilità termica thermal conductivity	EN 12524	-	$\lambda = 1,3 \text{ W/m}^\circ \text{ K} - 0.7 \text{ Btu/ft h}^\circ \text{ F}$
fuga minima consigliata** recommended minimum joint**	RETT-RECT (indoor) ESTERNO / OUTDOOR	- -	2mm 5mm circa / approx.
stonalizzazione shade variation	ANSI A137.1	come indicato dal produttore as indicated by manufacturer	V3

\*ad esclusione dell'acido fluoridrico e derivati  
excluding hydrofluoric acid and derivatives

\*\*salvo diversa indicazione dei Codici di Posa Nazionali. La larghezza delle fughe deve comunque essere decisa dalla Direzione Lavori  
the width of grout joints must be established by the installation supervisor, unless grout widths are regulated by national laying standards

## IMPIEGHI USES EMPLOI ANWENDUNGSBEREICHE

alberghi hotels hotels hotels	locali pubblici public spaces lieux publics öffentliche bereiche
abitazioni housing maisons wohnbereiche	aeroporti airports aéroports flughafen
bar - ristoranti bar - restaurants bar - restaurants cafés - restaurants, gasthäuser	centri commerciali malls centre commerciaux einkaufszentren
negozi shops magasins geschäfte	stazioni train stations gares bahnhöfe

## IMPIEGHI 20mm USES EMPLOI ANWENDUNGSBEREICHE

vialetti walkways allées Kleine Wege	parcheggi parking areas parkings Parkplätze
parchi pubblici - giardini public parks - gardens parcs publics et jardins Öffentliche Parks und Gärten	terrazze terraces terrasses Terrassen
camminamenti piscine pool decks voies piétonnes et piscines Wege und Schwimmbäder	zone industriali industrial areas zones industrielles Industriebereiche
stabilimenti balneari beach resorts établissements balnéaires Badeanstalten	aree urbane urban areas zones urbaines Stadtbereiche

## IMBALLAGGI / PACKING / EMBALLAGE / VERPACKUNGEN

articolo	scatola			europallet		
	pz.	mq	kg	scat.	mq	kg
fondo 10,5mm 60x120 24"x48"	2	1,44	35,5	15	21,6	532,5
fondo 10,5mm 90x90 36"x36"	2	1,62	40,0	15	24,3	600,0
fondo 10,5mm 45x90 18"x36"	3	1,22	30,0	30	36,5	900,0
fondo 20mm 45x90 18"x36"	2	0,81	36,2	24	19,4	869,5
fondo 10,5mm 60x60 24"x24"	4	1,44	32,5	32	46,1	1040,0
fondo 10,5 grip 60x60 24"x24"	4	1,44	33,0	32	46,1	1056,0
fondo 10,5 30x60 12"x24"	8	1,44	32,5	32	46,1	1040,0
muretto 30x60 12"x24"	4	0,72	15,6	30	21,6	468,0
muretto 3D 30x60 12"x24"	4	0,68	18,2	30	20,5	546,0
brick 30x60 12"x24"	4	0,72	15,6	30	21,6	468,0
mosaico 36 30x30 12"x12"	5	0,45	10,0	60	27,0	600,0
gramma 72 49,8x16,9 19 1/2"x6 5/8"	-	-	-	-	-	-
gramma 66 39,2x19,5 15 3/8"x7 5/8"	-	-	-	-	-	-
gramma 16 19,5x9,7 7 5/8"x3 3/4"	-	-	-	-	-	-
battiscopa 10x60 4"x24"	12	7,2 m.l.	16,0	60	432,0 m.l.	960,0
gradino plus 35x120 13 3/4"x48"	2	0,84	23,2	16	13,4	371,2
angolo gradino plus 35x120 13 3/4"x48"	1	0,42	12,4	16	6,7	198,4
gradino plus 35x60 13 3/4"x24"	4	0,84	21,2	16	13,4	339,2
angolo gradino plus 35x35 13 3/4"x13 3/4"	2	0,25	6,7	36	8,8	241,2
costa toro 30x90 12"x36"	1	0,27	12,2	32	8,6	390,4
costa toro angolare 30x90 12"x36"	1	0,23	10,2	32	7,2	326,4
costa retta 30x90 12"x36"	1	0,27	12,2	32	8,6	390,4
costa retta angolare 30x90 12"x36"	1	0,23	10,2	32	7,2	326,4
costa toro step 30x90 12"x36"	1	0,27	12,2	32	8,6	390,4
costa retta step 30x90 12"x36"	1	0,27	12,2	32	8,6	390,4
griglia 15x45 6"x18"	4	0,27	10,0	48	13,0	480,0
griglia angolare 15x45 6"x18"	4	0,23	10,0	48	10,8	480,0



ISO 14001



ISO 9001



emas



leed\*\*



leed\*



Le DOP sono disponibili sul sito internet [www.ceramichelea.it](http://www.ceramichelea.it)  
DOP are available on the website [www.ceramichelea.it](http://www.ceramichelea.it)

marchio CE

\* LEED  
Lea Ceramiche, è membro di GBC Italia, organizzazione che promuove sul territorio italiano la realizzazione di edifici nel rispetto dell'ambiente, della salute e del benessere delle persone che ci vivono e lavorano.  
Lea Ceramiche is a member of the U.S. Green Building Council: this is an organization that promotes buildings that are environmentally responsible, profitable and healthy places to live and work.

\*\* LEED  
Il contenuto di materiale riciclato "pre-consumo" della serie Waterfall è del 40%, come certificato da ente esterno qualificato (certificato disponibile sul sito [www.ceramichelea.com](http://www.ceramichelea.com)).  
Waterfall is produced with 40% of pre-consumer materials, as certified by a qualified external company (certificate available on the website [www.ceramichelea.com](http://www.ceramichelea.com)).



ADMEMBER



# PROTECT

L'esclusiva tecnologia Panariagroup per pavimenti e rivestimenti antibatterici ad altissime performance. Per un abitare sano, sicuro e protetto.

The exclusive Panariagroup technology for floor and wall coverings with the highest performance. To live healthy, safe and secure.

**AZIONE POTENTE**  
elimina i batteri e ne impedisce la proliferazione

---

**POWERFUL ACTION**  
eliminates microbes and prevents their reproduction

**PROTEZIONE CONTINUA**  
sempre attivo, 24 ore su 24, con e senza luce solare

---

**PROTECTION CONTINUE**  
always active, 24 hours a day, with and without sunlight

**EFFICACIA ETERNA**  
grazie alla tecnologia integrata in modo permanente nel prodotto

---

**ETERNAL EFFECTIVENESS**  
thanks to the technology permanently integrated into the product

**QUALITÀ GARANTITA**  
dalla partnership con MICROBAN®

---

**GUARANTEED QUALITY**  
by the partnership with MICROBAN®

More on [protect.panariagroup.it](http://protect.panariagroup.it)

# WATERFALL

**MATERIA MUTEVOLE**  
VARIABLE MATERIAL

## P R ( ) T E C T

SUPERFICIE ANTIBATTERICA  
ANTIMICROBIAL SURFACE

with **MICROBAN**<sup>®</sup>

# LEA

CERAMICHE

LEA CERAMICHE  
Via Cameazzo, 21  
41042 Fiorano Modenese  
Modena Italy

Tel +39 0536 837811  
Fax +39 0536 830326  
info@ceramichelea.it  
www.ceramichelea.com

Panariagroup Industrie Ceramiche  
S.p.A.

SHOWROOM LEA CERAMICHE  
Via Durini, 3  
20122 Milano

Tel +39 02 76011406  
showroom\_milano@ceramichelea.it

LEA NORTH AMERICA, LLC  
800 Clanton Road, Suite N  
Charlotte, NC 28217

Tel +1 704 522 6300  
Fax +1 704 522 6080  
info@leausa.us  
www.leausa.us